

CHAMPION COOLER / ESSICK AIR

INSTALLATION & OPERATION MANUAL FOR ASPEN WINDOW COOLERS

Circle the model of your cooler and record the serial number.

Date of Purchase _____

Serial Number _____

MODEL NUMBERS		
RWC35	RN35W	WCM28
RWC44	RN44W	N28W
RWC46	RN46W	
RWC50	RN50W	

IMPORTANT SAFETY INSTRUCTIONS READ BEFORE USING YOUR COOLER

⚠ WARNING: To reduce the risk of fire, electric shock or injury to persons, observe the following:

1. Do not use this fan with any solid-state fan speed control device.
2. Use this unit only in the manner intended by Champion Cooler/Essick Air. If you have questions, contact our customer service department.
3. When installing or performing any maintenance, the unit must be in the OFF position, unplugged from the power receptacle, power turned off at service panel and locked to prevent power from being switched on accidentally. When the service disconnecting means cannot be locked, securely fasten a prominent warning device, such as a tag, to the service panel.
4. This appliance has a polarized plug (one blade is wider than the other). Plug cooler directly into a 120V A.C. electrical outlet. Do not use extension cords. If the plug does not fully fit into the outlet, reverse plug. If it still does not fit, contact a qualified electrician to install the proper outlet. Do not change the plug in any way.
5. When cutting or drilling into wall or ceiling, do not damage electrical wiring and other hidden utilities.
6. Installation work and electrical wiring must be done by qualified person(s) in accordance with all applicable codes and standards, including fire-rated construction.
7. Install only on a circuit protected with a Ground Fault Circuit Interrupter (GFCI).
8. This appliance is not intended for use by children or adults with reduced physical, sensory or mental capabilities, or lack of experience and knowledge, unless they have been given supervision or instruction concerning use of the appliance by a person responsible for their safety. Children should be supervised to ensure that they do not play with the appliance.
9. Do not operate any unit with a damaged cord or plug. Contact customer service for troubleshooting, repair or return.
10. Do not run cord under carpeting. Do not cover cord with throw rugs, runners or similar coverings. Do not route cord under furniture or appliances. Arrange cord away from traffic area and where it will not be a trip hazard.

⚠ WARNING: Chemical Burn Hazard. Keep batteries away from children.

The remote control PN 110401-3 contains a lithium button/coin cell battery. If a new or used lithium button/coin cell battery is swallowed or enters the body, it can cause severe internal burns and can lead to death in as little as 2 hours. Always completely secure the battery compartment.

AAA battery is not included for remote usage. Always completely secure the battery compartment. If the battery compartment does not close securely, stop using the product, remove the batteries, and keep it away from children. If you think batteries might have been swallowed or placed inside any part of the body, seek immediate medical attention. The batteries shall be disposed of properly, as even used batteries may cause injury.

LIMITED WARRANTY

This warranty is extended to the original purchaser of an evaporative cooler installed and used under normal conditions. It does not cover damages incurred through accident, neglect or abuse by the owner. We do not authorize any person or representative to assume for us any other or different liability in connection with this product.

TERMS AND CONDITIONS OF THE WARRANTY

For one year from date of purchase, we will replace any original component provided by Champion Cooler which fails due to any defect in material or factory workmanship only.

EXCLUSIONS FROM THE WARRANTY

We are not responsible for replacement of evaporative media. These are disposable components and should be replaced periodically.

We are not responsible for any incidental or consequential damage resulting from any malfunction.

We are not responsible for any damage received from the use of water softeners, descale material or plastic distortion caused by chemicals.

We are not responsible for the cost of service calls to diagnose the cause of trouble, or labor charge to repair and/or replace parts.

HOW TO OBTAIN SERVICE UNDER THIS WARRANTY

Contact the dealer where you purchased the evaporative cooler. If for any reason you are not satisfied with the response from the dealer, contact:

Customer Service Department
 Champion Cooler
 5800 Murray Street
 Little Rock, Arkansas 72209
 1-800-643-8341
 info@championcooler.com

This limited warranty applies to the original purchaser only. Register your product online at championcooler.com.

OPEN VENTILATION SYSTEM

Unlike traditional air conditioners, evaporative coolers will not work in a closed room. **Both a fresh air source and an exhaust opening are required** to provide correct air flow.

For best results, the open windows or doors should not be on the windward side on the house.

Unlike refrigerated systems, evaporative coolers can continually bring fresh air in, while exhausting old air every 2 to 4 minutes. This allows the air to always be fresh, not stale or laden with smoke and odors.

Ensure the selected window has sufficient open air around it and is not inhibited by nearby buildings.

Alternately, attic ventilation ducts such as UP-DUX® can be installed to provide sufficient air movement without requiring open windows.

TOOLS NEEDED FOR INSTALLATION

- Electric drill with 3/16" bit
- Two adjustable wrenches
- Screwdrivers
- Bubble level

NOTE: Two persons are required for best installation results. To ensure the intended window is adequate for the size of the cooler see the chart below.

REQUIRED WINDOW OPENING CLEARANCES (STANDARD INSTALLATION)		
MODEL #	WIDTH	HEIGHT
RWC35/RWC44/RWC46/RWC50	21.75"	14.75"
RN35W/RN44W/RN46W/RN50W	21.75"	14.75"
WCM28/N28W	21.75"	11"

SPECIFICATIONS

GENERAL SPECIFICATIONS

Model No.	Weight (lbs.)		Cabinet Dimensions (in.)			Window Opening Req'd (in.)	
	Dry	Operating	Height	Width	Depth	Width	Height
RWC35, RN35W	113	190	30 3/4	31 1/2	21	21 3/4	14 3/4
RWC44, RN44W RWC46, RN46W	152	246	34 1/2	34 1/8	34 1/8	21 3/4	14 3/4
RWC50, RN50W	155	249	34 1/2	34 1/8	34 1/8	21 3/4	14 3/4
WCM28, N28W	65	105	27	24	17	21 1/4	11

MOTOR SPECIFICATIONS

RWC35, RWC44, RWC26, RWC50, RN35W, RN44W, RN46W, AND RN50W

Model No.	Motor Part #	HP	Speed	Volts	Motor Pulley Part #	Drive Belt # (Size)	Pump Part #
RWC35, RN35W	110445	1/3	2	115	110271	110226 (4L-480)	110429
RWC44, RN44W, RWC46, RN46W	110445	1/3	2	115	110272	110215 (4L-560)	110429
RWC50, RN50W	110447	1/2	2	115	110273	110215 (4L-560)	110429

ELECTRICAL SPECIFICATIONS

WCM28 AND N28W

Model No.	Motor Part #	Volts	Motor Speed	Motor Amperage	Pump Amperage
WCM28, N28W	110441-1C	115	2	4.0	0.7

BEFORE INSTALLATION

This cooler comes fully assembled. Additional features may require some assembly. Window installation kit is shipped inside the cooler body.

1. Extract the cooler from packaging.
2. Access the interior of the unit.

RWC35, RWC44, RWC46, RWC50, RNC35, RNC44, RNC46, RNC50:

Remove two (2) screws at the top of the back louver panel.

WCM28, N28W: Remove one (1) screw at the top center of the back louver panel.

3. Pivot the bottom out and lift the panel away.
4. Verify unit is in good shape and lift out the parts bag inside unit.
5. Dispose of packing material responsibly.
6. For ease of installation, leave the louvered sides off the unit to reduce the weight during installation.

MOUNTING OPTIONS

This window unit comes with an installation kit that includes a chain kit and two adjustable leg brackets that act as stabilizing spacers when a unit is installed with a flush-mounted grill inside the window. This kit is not required, but some form of structural support will be needed for these units due to the operating weight of these coolers. Refer to the general specifications table on page 6.

If installing the unit without the use of the installation kit, skip these directions and proceed to mounting procedure.

1. Locate the two (2) standoff brackets, two (2) phillips head screws and two (2) weld nuts from the bag kit. Insert a screw into the center hole on each bracket and install a weld nut onto the screw.
2. At each forward corner of the cooler, remove the two (2) screws attaching the body to the bottom pan.
3. Install the standoff bracket at each forward corner by using the removed screws (one per side, using the top holes on the bracket).
4. Install one (1) house leg through each bracket.

EXTERIOR MOUNTING PROCEDURE

CAUTION: Ensure any wood in the window facing that will be receiving the supporting chain hardware is sound and capable of supporting the full operating weight of the unit. DO NOT attempt to hold cooler in place by simply closing window on the neck. Additional support **MUST** be in place even for short periods of time.

NOTE: If mounting the chain kit into something other than wood, (i.e.: concrete, brick) purchase appropriate anchors at your local hardware store. Fully install the anchors into the surface to ensure the unit is adequately supported.

1. Using the contents of the installation kit, install the hooks into the structure at the same width as the cooler body. Attach one (1) chain to each hook.
2. Locate a small hole on each side of the cooler top pan toward the back. These are the mounting holes for securing the S-hooks.
3. Adjust house legs (if installed). Pull them out to point where rubber bumpers rest against house and tighten screw in retaining collar to secure.
4. Adjustments may be necessary after interior installation is complete.

INTERIOR MOUNTING PROCEDURE

With the cooler grille section inside the window, slide a black retainer strip onto the bottle neck flange. Trim to fit the width of window as necessary. The upper retainer strip will be installed in a subsequent step. These retainers hold the blocking panels in position.

1. Ensure cooler unit is positioned as desired in the window and measure each portion of the window that must be covered with the blocking panels. Measure and score the black blocking panel with sharp knife against a straight edge at the desired length. The blocking panel can be snapped to the desired length by laying the panel over a flat surface at the point to be broken off. Apply pressure on the overhanging portion of the blocking panel to create a clean break.
2. Install window panel retainers. Place two (2) panel retainer strips onto bottom flange of cooler neck and position to the width of the window. Cut the strips to fit if necessary. These strips hold the window blocking panel.
3. Install blocking panels on each side of the grill. Insert the blocking panels into the panel retainer strips. Once in place, install the top retainer strips onto the top flange of the cooler neck and the blocking panels. Be sure the blocking panels are snug up against cooler neck.
4. Raise back of cooler so that the window may be brought down behind top of panel retainer strip. Ensure unit is level and re-adjust chain length and the house legs so the bumper rests against the house. Tighten screw in the house leg bracket to secure the leg.
5. Seal around the window panels and retaining strips with caulk for proper cooling.

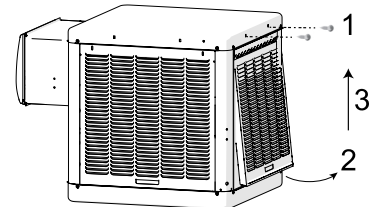

RWC35, RWC44, RWC46, RWC50, RNC35, RNC44, RNC46, RNC50

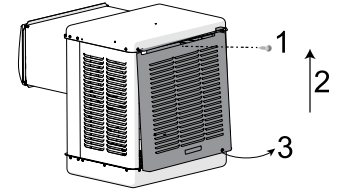

WCM28 or N28W

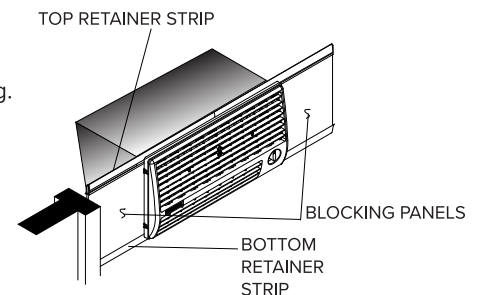
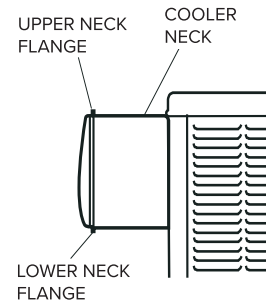
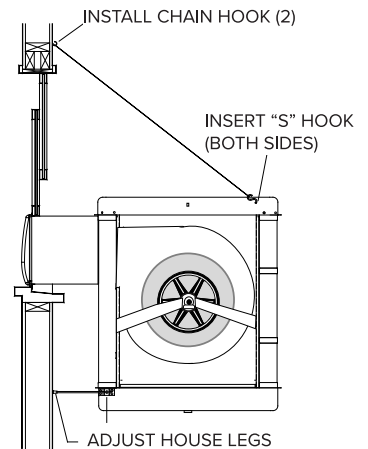
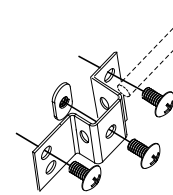
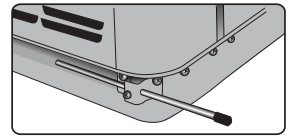

OPTIONAL VERTICAL MOUNTING PROCEDURE

The WCM28 and N28W models cannot be installed vertically.

The conversion kit is not shipped with the unit, but may be acquired at no cost by calling customer service at 800-643-8341.

CAUTION: Because of the stress load on the cooler tunnel when mounting a cooler with this type of vertical tunnel configuration, the unit should be supported by a flat support or stand. **The installation method of legs and chain should not be used.**

1. Remove the nine (9) screws from the sides and bottom of the tunnel.
2. Remove the top four (4) middle screws of the top pan while holding the tunnel in place. Be careful not to drop the tunnel, as damage to the electric cords could occur. You may need to loosen other screws in the top pan to make it easier to remove the tunnel.
3. Rotate the tunnel 90 degrees counter-clockwise.
CAUTION: Be careful as you rotate the tunnel that you don't damage or disconnect the cords which are still connected to the controls and the front panel.
4. Insert the flange of the tunnel between the front panel and the top pan. Line up the two larger holes in the tunnel with the center two holes of the top pan. Using the screws taken from the top pan, secure the tunnel to the unit. Do not tighten the screws, leave them loose until the rest of the tunnel has been secured.
5. Line up the three holes at the bottom of the tunnel with the holes in the front panel. Using the screws taken from the bottom of the tunnel previously, secure the tunnel to the front panel.
6. Make sure all the screws removed from the top pan are in place. Now tighten all screws. (Remove the nine (9) screws from the sides of the front panel in step 1).
CAUTION: Make sure that you do not remove the bottom most screw. It holds the blower housing in place.
7. To cover up the gap in the front panel, use the two strips of metal included in the conversion kit. Line up the holes in the metal strips to the holes in the front panel and secure them with the screws previously removed in step 1. When properly installed there should be no gap between the top pan and the metal strip. If there is a gap, turn the metal strip around.
8. If desired, use the filler panels in the installation kit to seal off the window above the cooler duct.
9. Once mounting is completed, we recommend installing a screw or stop, to prevent the window being opened and allowing the cooler to fall.

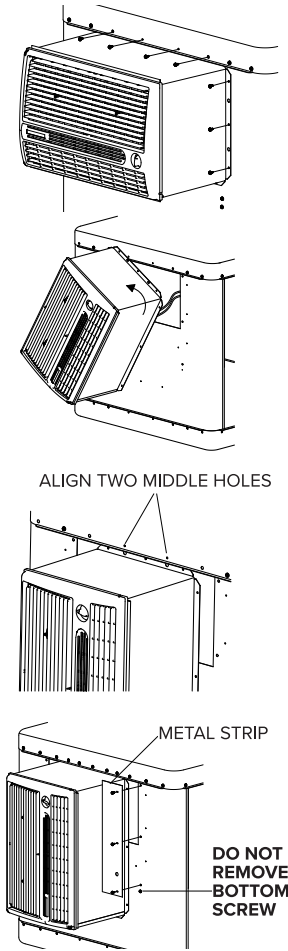

OVERFLOW DRAIN ASSEMBLY INSTALLATION

1. Install overflow assembly through the hole in bottom.
 - a. Remove nut and place nipple through the hole in the pan with the rubber washer between the pan and the head of the drain nipple.
 - b. Screw on nut and draw up tight against bottom of pan.
 - c. Insert overflow pipe in nipple to retain water. The overflow pipe may be removed to drain the pan when necessary.

NOTE: A garden hose may be screwed onto the drain nipple to divert water away from your unit and foundation.

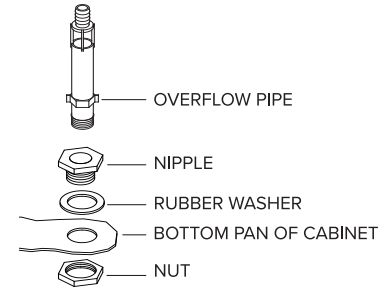

WATER CONNECTION OPTIONS

Steady water supply is required for operation of the cooler. There are two options for attaching water to the cooler: Leave the water supply turned off until ready to test the connections.

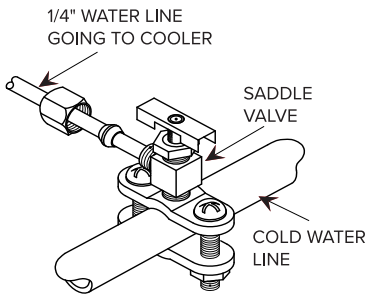

PERMANENT CONNECTION

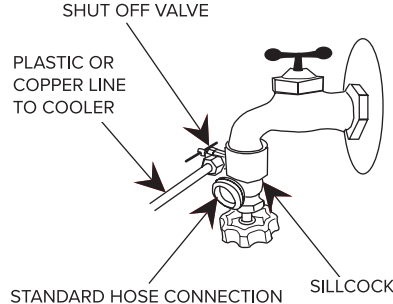

SILLCOCK CONNECTION

1. Permanent installation into plumbing.
 - a. Locate existing cold water line inside house to draw water source from.
 - b. Install saddle valve into cold water line and attach a 1/4" water supply line going to the cooler.
 - c. Keep valve closed until installation is complete.
2. A sillcock can be installed on an external faucet to accommodate the water supply.
 - a. Install a shutoff valve and sillcock onto the outdoor faucet.
 - b. Attach a 1/4" copper or plastic water line onto the shutoff valve by placing the nut and ferrule on the tubing and hand tightening the nut until tight then use a wrench for the final quarter turn. **Do not overtighten.**

CAUTION: Do not connect the water supply to any soft water applications.

FLOAT VALVE INSTALLATION

1. Remove the felt washer, lock nut, ferrule and compression nut attached at the end of the float valve.
2. Place the compression nut on the water line (with the threaded end at the end of the water line).
3. Install the ferrule on the end of the water line.
4. Inside the bottom pan, insert the float valve through the predrilled hole in the corner post. Install the felt washer on the float threads to protect the cooler's finish.
5. Install and hand-tighten the lock nut to keep float from turning.
6. Draw the compression nut over the ferrule and securely tighten by hand.
7. Using a wrench, tighten the final quarter turn. **Do not overtighten.**
8. Before operating the cooler, bend the float rod so the water level will be about an inch below the top of the overflow tube. Allow the water pan to fill and verify the float valve turns the water off at the right level.

CAUTION: Overtightening the connection can lead to possible water leakage. For best results secure the connections, turn on the water then snug up any connections that leak.

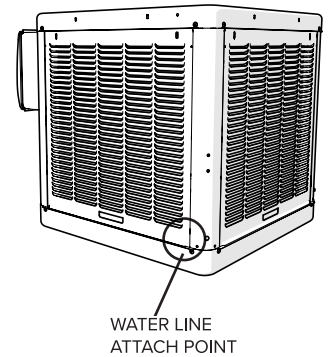

OPERATION

RWC35, RWC44, RWC46, RWC50, RNC35, RNC44, RNC46, RNC50

The functions of the window cooler can be operated by the control panel on the front of the unit or from the remote control. There is a 2-second delay between pressing the button and the cooler's response.

1. When starting the cooler for the first time (or after a power failure), pressing the ON/OFF button will turn the unit on in its default setting: Pump **ON** and Fan on **HI**.

General operating instructions:

- Press ON/OFF to apply power to the cooler. Light will illuminate.
- Press FAN button once for HI speed. HI Indicator light illuminates.
- Press a second time for LO speed. LO Indicator light illuminates.
- Press a third time to turn the fan OFF. No fan light illuminated.
- Press PUMP button to toggle between power on or off to the PUMP. Indicator light will illuminate when the pump circuit has power.

2. After the initial use, the last settings will be retained upon the next power-up.
3. Each of the buttons operate independently, and can be initiated in any order.
4. If the unit is ON in any function, pressing the POWER button once will turn all functions off.
5. Indicator lights on the control panel will illuminate to show what settings are active.

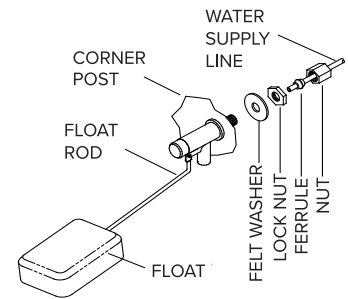

TIPS FOR MOST EFFECTIVE COOLING

1. Push the PUMP button on the control panel or the corresponding button on the remote control about 5 minutes before turning on the fan. This will cause water to begin cycling and saturate the pads. The PUMP indicator light will illuminate.
2. After the pump has run a few minutes, press the FAN button on the control panel or on the remote. The fan will start in Hi speed. As soon as practical, press the FAN button again to reduce to Lo Speed. This lower speed causes the air to stay among the wet pads longer and therefore increase the cooling efficiency.

NOTES: The pump will automatically turn on when the Fan HI or LO position is selected. If you only want ventilation, and not the cooling effects, press PUMP button to turn it off.

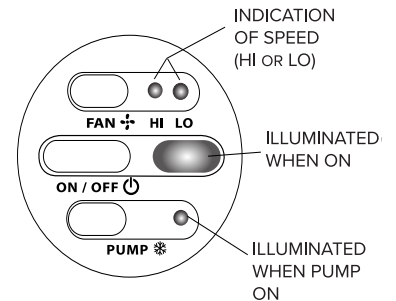

REMOTE CONTROL USAGE

Like the control panel, the buttons on the remote control are independent, and can be activated in any order. To operate the cooler with the remote you must be within 20 feet and in sight of the cooler.

Aim the remote at the front panel. The buttons on the remote control have the same functions as the buttons on the front panel of the cooler. The 110401-1 remote uses two AAA batteries. The 110401-3 remote uses a CR2025 button battery. Remove any protective keeper from the remote and install the supplied battery(ies). A holder for mounting the remote on the wall is also included with the remote.

- (PUMP) button. Pressing this button toggles the pump on and off. When the LED on the control panel is lit, the pump is running. Use the pump when cooling is desired, and turn it off for ventilation only.
- (FAN) button. Pressing this button will cycle the fan through High Speed / Low Speed / Off. The LED's on the front of the control indicate whether the fan is on high speed, low speed or off (no LED's lit). **Note:** There will be a 2 second delay between a button press and the operation of the fan.
- (POWER) button. Pressing this button while the pump or fan is on will turn everything off. When Powering the unit up for the first time it will start in default mode: Fan HI, Pump ON. Subsequently, it will start the machine in the settings last used.

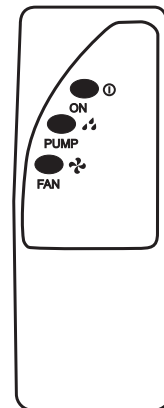

PN110401-1
PRE 2022 UNITS

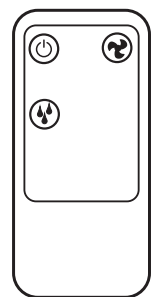

PN110401-3
2022 AND
SUBSEQUENT
UNITS

WCM28 OR N28W

The functions of the window cooler can be operated by the control panel on the front.

1. When first starting the unit, turn the knob to "Pump Only" to initiate the pump. Leave it on for 3-5 minutes to pre-wet the pads.
2. Turn the switch knob to High Cool or Low Cool to start the fan at the selected speeds. The pump will continue to run. Turn the unit to "Low Cool" when possible. This lower speed allows the air to stay longer in the wet pads and therefore increases its cooling efficiency.

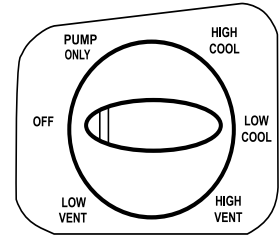

VENT MODE

1. Fresh air ventilation only may be desired at various times, such as nighttime or when the humidity is especially high. Turn the knob to the HIGH VENT or LOW VENT position without the pump being turned on and just the fan will run. For best results, always open a window in the rooms you desire to cool.

FOR BEST RESULTS

- To eliminate the delivery of hot air when starting the cooler, start the pump only for the first few minutes, then turn on the blower motor.
- This cooler may be used without water for ventilation purposes. When outside air is cool (for example, at night) or when humidity is high the water pump can be turned off.

MAINTENANCE

RWC35, RWC44, RWC46, RWC50, RN35W, RN44W, RN46W AND RN50W

NOTE: Regular maintenance on your cooler will increase performance and extend the life of your cooler. During the season, periodically drain and clean the bottom pan. This will help keep hard water deposits from accumulating in the pan which can decrease cooling efficiency and decrease the life of the cooler. Replace the aspen pads once or twice a season. Clean pads are essential for effective cooling.

⚠ WARNING: To prevent electrical shock, always ensure power is off and unit is unplugged before doing any maintenance.

CONTROL: The control module is a component that can be replaced if needed. Follow the diagram below to install a new module.

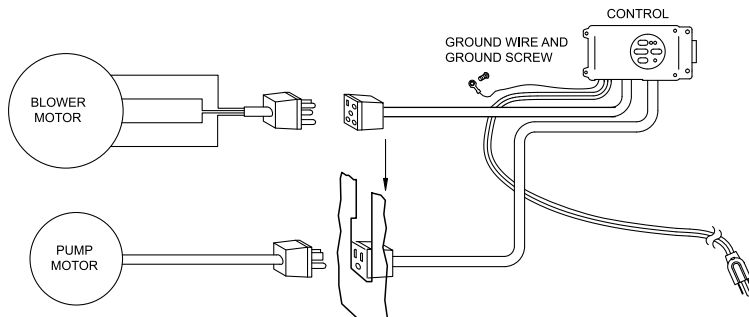

WIRE COLOR	120 VAC CONNECTIONS
RED WIRE	HOT - Lo
BLACK WIRE	HOT - Hi
WHITE WIRE	COMMON
GREEN WIRE	GROUND

START OF SEASON MAINTENANCE

Accomplish these basic steps in the spring, before cooling will be needed, in case you have to acquire replacement parts.

1. Change the aspen pads at least once per season. Keeping the pads clean will increase the efficiency of the cooler.
2. Oil the blower bearings each year, by locating the port door on each of the two bearings holding the blower shaft in place. Open the spring loaded doors and add a few drops of non-detergent 20/30 weight oil.

MOTOR: The original motor installed in this cooler is thermally protected and has sealed lifetime oil, requiring no maintenance. If you have replaced the original motor: Follow the manufacturer's recommendations for maintenance.

CAUTION: Do not over oil the motor, as this can cause the motor to burn out due to excessive oil on windings.

PUMP: Accomplish for main pump, and for purge pump, if installed.

1. The pump should be cleaned at least once yearly, or more often if debris accumulates.
2. Unplug motor and pump from junction box, and disconnect water tube, if not already accomplished.
3. A plastic dart plug is inserted from the bottom to secure the pump upright. Use a screwdriver to pry the fastener out.
4. Extract pump from the mesh filter and remove base of pump.
5. Clean pump, turn impeller to ensure free movement.
6. Remove hose from pump spout and verify no blockage.
7. To prevent the pump seizing up from corrosion, do not allow water to enter the upper pump body.
8. Before reinstalling pump, check water hose, bleed off line and overflow to ensure there is no blockage in any lines. Rinse mesh filter and reattach.

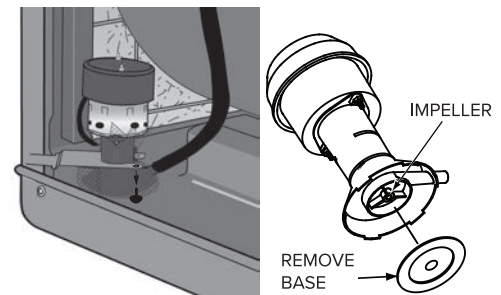
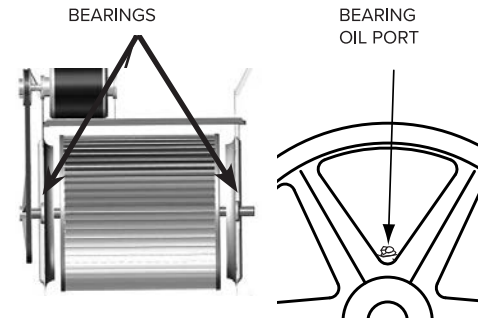

- Reinstall the pump by sliding pump onto mounting bracket and reinserting the plastic dart fastener to ensure pump stays in upright position.
- Reinstall water line to pump outlet.

BELT TENSION

- Before unit is turned on, check that the belt is in good condition.
- If belt must be replaced, refer to the specifications for correct part number, and install new belt. Verify belt tension is correct: 3/4" deflection with three (3) lbs of force.

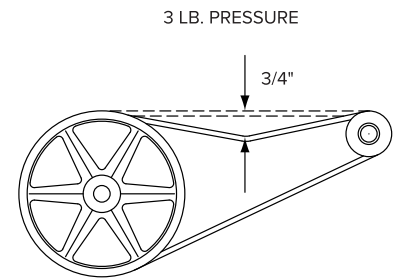

WCM28 AND N28W

NOTE: Regular maintenance on your cooler will increase performance and extend the life of your cooler. During the season, periodically drain and clean the bottom pan. This will help keep hard water deposits from accumulating in the pan which can decrease cooling efficiency and decrease the life of the cooler. Replace the aspen pads once or twice a season. Clean pads are essential for effective cooling.

⚠ WARNING: To prevent electrical shock, always ensure power is off and unit is unplugged before doing any maintenance.

MOTOR AND BLOWER

This cooler has a direct drive motor / blower assembly. Neither the dual blower wheel nor the original motor require oiling. If you replace these components, follow the manufacturer's instructions.

PUMP

Pre-season check should include a thorough check and cleaning of the pump.

- Disconnect the pump plug from the outlet on the back of blower housing.
- Use a screwdriver to pry the plastic fastener out of the pump bracket and slide the pump straight out of the bracket. Lift the pump away.
- Extract pump from the mesh filter and remove base of pump.
- Clean pump, turn impeller to ensure free movement.
- Remove hose from pump spout and verify no blockage.
- To prevent the pump seizing up from corrosion, do not allow water to enter the upper pump body.
- Before reinstalling pump, check water hose, bleed off line and overflow to ensure there is no blockage in any lines. Rinse mesh filter and reattach.
- Reinstall the pump by sliding pump onto mounting bracket, and replacing the plastic dart fastener to ensure pump stays in upright position.
- Reinstall the water distribution hose onto the pump spout and connect the other end to the water distribution nozzle at the top center of the cooler.
- Plug pump cord back into outlet and reinstall water line to pump outlet.

INTERIOR VIEWS

FROM FRONT

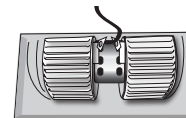

MOTOR/BLOWER ASSEMBLY

FROM BACK

UNPLUG PUMP

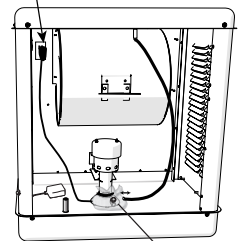

DISCONNECT WATER DISTRIBUTION LINE

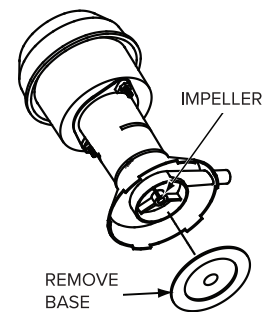

IMPELLER

REMOVE BASE

END OF SEASON SHUTDOWN

The cooler should be prepared before any extended period of non use, and especially before winter shutdown.

- Drain all water from unit, supply line and pump to ensure no damage occurs from freezing.
- Keep water line disconnected from both unit and supply line.
- Disconnect motor and pump from power. And if desired, take pump indoors to prevent damage from freezing.
- Cover unit to protect finish for long periods of non use.
- To prevent premature deterioration of the cooler cabinet, we recommend sanding and repainting any areas where the cabinet finish is showing wear or rust.
- Replace aspen pads at beginning of next season.

TROUBLESHOOTING

PROPER AIR FLOW FOR ALL ASPEN COOLERS

An often misunderstood concept of evaporative cooling is the amount of air that should be exhausted. How much should you open your windows? The fact is that most people do not open their windows enough. The following method will help you determine the amount to open your windows.

AIR BALANCING METHOD

- Take a piece of tissue paper and cut it lengthwise into three (3) equal strips.
- Turn your cooler on high cool.
- Open one window at least six (6) inches wide in each room that you want to cool.
- Take the piece of tissue paper and put it up against the screen of the open window furthest from the cooler discharge opening. Let go of it.
 - If it falls down, then CLOSE all of the windows one inch and try step 4 again.
 - If it plasters itself to the screen, then OPEN all of the windows one (1) inch and try step 4 again.
 - If it stays on the screen lightly, then PERFECT. You are done. Enjoy your cooler.

NOTES :

- When switching to low cool, you must rebalance your home. Repeat step 4.
- Once you balance your home you can cool some areas more than others by opening those windows more and closing the others by the same amount. Repeat step 4 to make sure your home is still air balanced.

TROUBLESHOOTING		
PROBLEM	POSSIBLE CAUSE	REMEDY
Failure to start or no air delivery	1. No electrical power to unit	1. Check Power
	• Blown Fuse or Tripped Circuit Breaker	• Replace fuse or reset breaker
	• Electrical cord unplugged or damaged	• Plug in cord or replace cord if damaged.
	2. Belt too loose or too tight	2. Adjust belt tension
3. Motor overheated	3. Determine cause of overheating	
	• Belt too tight	• Adjust pulley tension
	• Blower bearings dry	• Oil blower bearings
	4. Motor locked	4. Replace motor
Inadequate air delivery with cooler running	1. Insufficient air exhaust	1. Open doors or windows to increase air flow
	2. Belt too loose	2. Adjust belt tension or replace if needed
	3. Pads plugged/dirty	3. Clean or replace pads
Water draining from cooler	1. Float arm not adjusted properly	1. Adjust float
	2. Overflow assembly leaking	2. Tighten nut and overflow pipe
Musty or unpleasant odor	1. Stale or stagnate water in cooler	1. Drain pan and clean or replace pads
	2. Pads mildewed or clogged	2. Replace pads
	3. Pads not wetting properly	3. Check water distribution system
	• Trough holes clogged.	• Clean trough
• Pump not working properly	• Unplug unit and clean or replace pump	
• Insufficient water flow over pads	• Clean distribution system and trough openings	
Motor cycles on and off	1. Low voltage	1. Check voltage
	2. Excessive belt tension	2. Adjust belt tension
	3. Blower shaft and tight or locked	3. Unplug unit and oil or replace bearings
	4. Bearings dry	4. Oil bearings
	5. Motor pulley diameter too large, causing motor overload	5. Adjust pulley so full load ampere rating of motor is not exceeded.
	6. Wheel rubbing blower housing	6. Unplug unit, inspect and realign
	7. Faulty motor	7. Replace motor
Noisy	1. Bearings dry	1. Oil bearings
	2. Wheel rubbing blower housing	2. Unplug unit, inspect and realign
	3. Loose parts	3. Tighten loose parts
Inadequate cooling	1. Inadequate exhaust in house	1. Open windows or doors to increase air flow
	2. Pads not wet	2. Check water distribution system
	• Pads clogged	• Clean pads
	• Water distribution tube holes clogged	• Clean tube holes
	• Water distribution system clogged	• Disconnect and wash or blow out the lines
• Pump not working properly	• Unplug and replace or clean pump	
Excessive humidity in house	1. Insufficient air exhaust	1. Open doors or windows